



ARCHITECTURAL HARDWARE  
HERRAJES ARQUITECTÓNICOS

ALUMINUM COLLECTION  
CABINET, PULLS AND KNOBS /  
COLECCIÓN JALADERAS DE ALUMINIO





ARCHITECTURAL HARDWARE / HERRAJES ARQUITECTÓNICOS

## Who are we?

We are a Mexican business dedicated to the manufacturing, sale and distribution of high quality dependable fittings.

Stemming from a long family history of hardware distribution in the heart of Mexico, Jako branched off in 2001 and began its independent operations in the city of Cancun. It has since rapidly matured into what has now become the leading architectural hardware company in the southeast of Mexico.

Jako builds its strength on the numerous warehouses fully stocked with an extensive line of products, in addition to, an impressive infrastructure and organized logistics for the efficient and precise distribution to all the major cities in Mexico and Latin America. This is backed by our sister company, LNS Manufacturing, which provides us the backbone to rapidly respond to any client need or demand, including customized products, designs, and ideas.

With the intention of being at the forefront, we are constantly at work enhancing our catalog of products ensuring that our customers have access to only the most innovative and cutting-edge hardware in areas such as doors, furniture, kitchen and glass fittings. Our family is committed to bring to you only the best in style, design and innovative solutions positioning Jako amongst the avant-garde.



## ¿Quiénes somos?

Somos una empresa con sede en México dedicada a la manufactura, venta y distribución de herrajes arquitectónicos de alta calidad.

A partir de una larga historia familiar de distribución de herrajes en el corazón de México, Jako se separó en el año 2001 y comenzó sus operaciones de forma independiente en la ciudad de Cancún. Desde entonces, ha madurado rápidamente hasta convertirse en la empresa líder en herrajes arquitectónicos en el Sureste de México.

Jako se basa en los numerosos almacenes completamente abastecidos con una extensa línea de productos, además de una impresionante infraestructura y logística que permite una distribución eficiente y precisa a cada una de las principales ciudades de México y América Latina. Nuestra compañía hermana LNS Manufactura nos proporciona el respaldo necesario para satisfacer cualquier necesidad o demanda del cliente, incluidos productos y diseños únicos.

Con la intención de estar a la vanguardia, estamos trabajando constantemente para mejorar nuestro catálogo de productos, garantizando que nuestros clientes tengan acceso únicamente a diseños más innovadores y vanguardistas en Herrajes y Accesorios para puertas, muebles, cocinas y cristal. Nuestra familia Jako está comprometida a brindarle soluciones innovadoras, al igual que solo lo mejor en diseño y estilo, posicionando a Jako a la vanguardia.

### LOCATION IN / PRESENCIA EN

- 📍 Cancún
  - Chichén Itzá
  - Huayacán
  - Cedis Colegios
  - Fabrica LNS Manufactura
- 📍 Playa del Carmen
- 📍 Mérida
- 📍 Querétaro
- 📍 Guadalajara
- 📍 Monterrey
- 📍 León, Guanajuato
- 📍 San Luis Potosí
- 📍 Tulum
- 📍 Miami







## ORGANIZATIONAL CULTURE / CULTURA ORGANIZACIONAL

### MISSION / MISIÓN

To offer SOLUTIONS and HIGH quality service to our customers, handling a wide variety of good quality products, with competitive prices and innovative products, making our customer service the BEST with respect and reliability. /

Ofrecer SOLUCIONES y ALTA calidad de servicio a nuestros clientes, manejando una amplia variedad de productos de buena calidad, con precios competitivos y productos innovadores, haciendo de nuestro servicio al cliente el MEJOR con respeto y confiabilidad.

### VISION / VISIÓN

To place us in the first position within the market as a LEADER at a national level, positioning JAKO in all the most important cities of Mexico through BRANCHES JAKO, distributors or representatives. Focusing on giving the best service to hotel and residential projects. As well as expanding and positioning the JAKO brand to other countries in Latin America and the USA. /

Ubicarnos en la primera posición dentro del mercado como LIDER a nivel nacional, posicionando a JAKO en todas las ciudades más importantes de México a través de SUCURSALES JAKO, distribuidores o representantes. Enfocándonos a dar el mejor servicio a proyectos de hoteles y residenciales. Así como expandir y posicionar la marca JAKO a otros países tanto en América latina como USA.

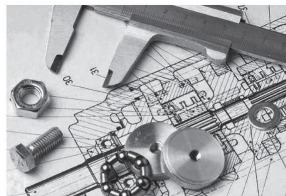
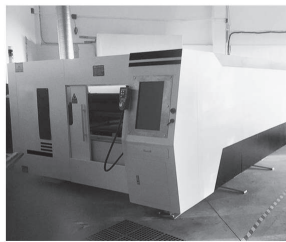

### OUR VALUES / NUESTROS VALORES

Respect / Respeto

Teamwork / Trabajo En Equipo

Responsibility / Responsabilidad

Commitment / Compromiso

Perseverance / Perseverancia

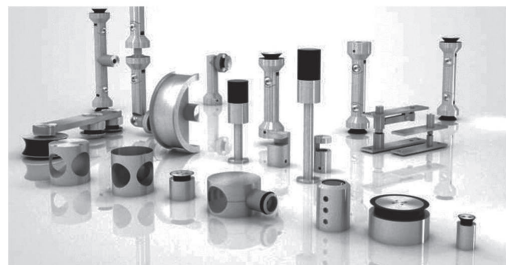



**WIN350**

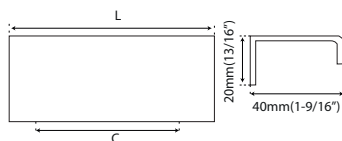
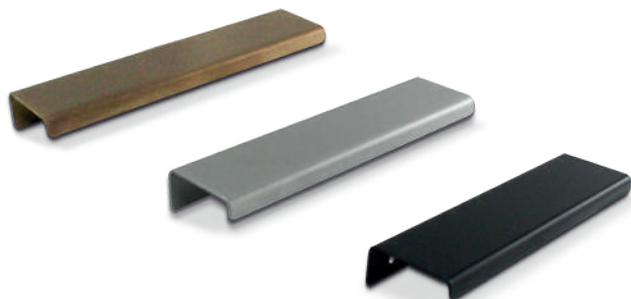

Material: Aluminum - Includes cut-out screws / Material: Aluminio - Incluye tornillos recortables

CODE / CÓDIGO	FINISH / ACABADO	C	L	
WIN35025GG	● Titanium/Titanio	25mm(1")	44mm(1-3/4")	50/500
WIN35025MB	● Black/Negro	25mm(1")	44mm(1-3/4")	50/500
WIN35025MTG	● Matt Brass/ Latón Mate	25mm(1")	44mm(1-3/4")	50/500
WIN35096GG	● Titanium/Titanio	65mm(2-9/16")	96mm(3-3/4")	25/200
WIN35096MB	● Black/Negro	65mm(2-9/16")	96mm(3-3/4")	25/200
WIN35096MTG	● Matt Brass/ Latón Mate	65mm(2-9/16")	96mm(3-3/4")	25/200
WIN350128GG	● Titanium/Titanio	128mm(5-1/16")	160mm(6-5/16")	20/200
WIN350128MB	● Black/Negro	128mm(5-1/16")	160mm(6-5/16")	20/200
WIN350128MTG	● Matt Brass/ Latón Mate	128mm(5-1/16")	160mm(6-5/16")	20/200
WIN350160GG	● Titanium/Titanio	160mm(6-5/16")	192mm(7-9/16")	15/150
WIN350160MB	● Black/Negro	160mm(6-5/16")	192mm(7-9/16")	15/150
WIN350160MTG	● Matt Brass/ Latón Mate	160mm(6-5/16")	192mm(7-9/16")	15/150
WIN350224GG	● Titanium/Titanio	194mm(7-5/8")	224mm(8-13/16")	20/200
WIN350224MB	● Black/Negro	194mm(7-5/8")	224mm(8-13/16")	20/200
WIN350224MTG	● Matt Brass/ Latón Mate	194mm(7-5/8")	224mm(8-13/16")	20/200
WIN3501000GG	● Titanium/Titanio	970mm(38-3/16")	1000mm(39-3/8")	20/200
WIN3501000MB	● Black/Negro	970mm(38-3/16")	1000mm(39-3/8")	20/200
WIN3501000MTG	● Matt Brass/ Latón Mate	970mm(38-3/16")	1000mm(39-3/8")	20/200





**RUSIA**

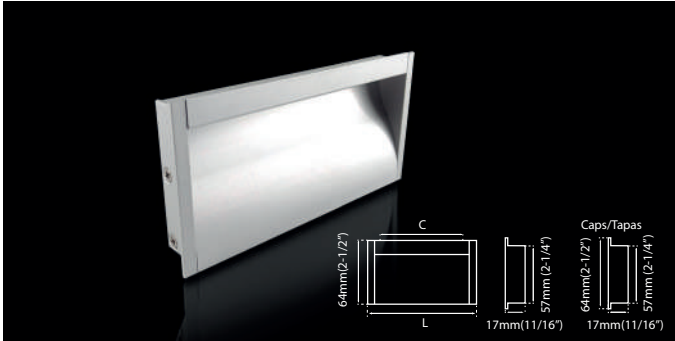

Material: Aluminum-Includes cut-out screws Material: Aluminio-Incluye tornillos recortables

CODE / CÓDIGO	FINISH / ACABADO	C	L	⊗
EM030-064-RUSIA	● Aluminum/Aluminio	64mm (2-1/2")	87mm (3-7/16")	25/150
EM030-096-RUSIA	● Aluminum/Aluminio	96mm (3-3/4")	127mm (5")	20/120
EM030-3000-RUSIA	● Aluminum/Aluminio	PROFILE / PERFIL	3000mm (118")	1/10
EM030-CAPS	● Aluminum/Aluminio	CAPS / TAPAS		1/200

**ECUADOR**

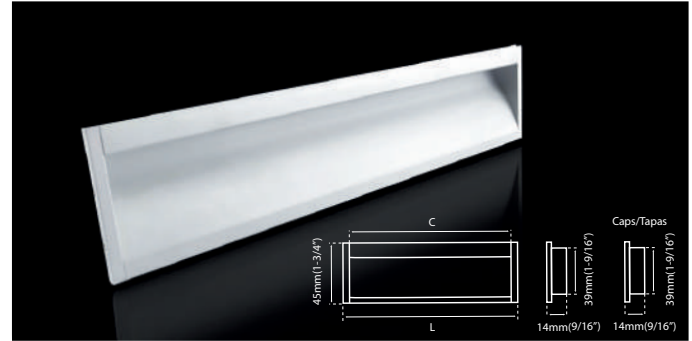

Material: Aluminum-Includes cut-out screws Material: Aluminio-Incluye tornillos recortables

CODE / CÓDIGO	FINISH / ACABADO	C	L	⊗
EM140-096-ECUADOR	● Aluminum/Aluminio	96mm (3-3/4")	125mm (4-15/16")	20/120
EM140-128-ECUADOR	● Aluminum/Aluminio	128mm (5-1/16")	155mm (6-1/8")	20/120
EM140-128-ECUADOR MB	● Black/Negro	128mm (5-1/16")	155mm (6-1/8")	20/120
EM140-160-ECUADOR	● Aluminum/Aluminio	160mm (6-5/16")	205mm (8-1/16")	20/180
EM140-224-ECUADOR	● Aluminum/Aluminio	224mm (8-13/16")	305mm (12")	15/60
EM140-3000-ECUADOR	● Aluminum/Aluminio	PROFILE / PERFIL	3000mm (118")	1/12
EM140-CAPS	● Aluminum/Aluminio	CAPS / TAPAS		1/200

**UCRANIA**

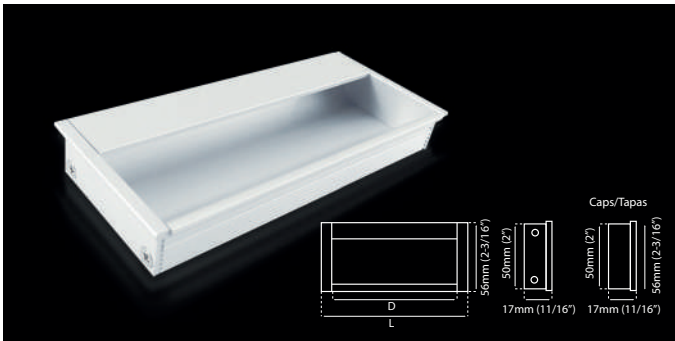

Material: Aluminum-Includes cut-out screws Material: Aluminio-Incluye tornillos recortables

CODE / CÓDIGO	FINISH / ACABADO	D	L	⊗
EM134-096-UCRANIA	● Aluminum/Aluminio	120mm (4-3/4")	124mm (4-7/8")	20/80
EM134-128-UCRANIA	● Aluminum/Aluminio	150mm (5-7/8")	156mm (6-1/8")	20/80
EM134-160-UCRANIA	● Aluminum/Aluminio	199mm (7-13/16")	206mm (8/18")	20/80
EM134-224-UCRANIA	● Aluminum/Aluminio	300mm (8-1/4")	306mm (12-1/16")	20/80
EM134-3000-UCRANIA	● Aluminum/Aluminio	PROFILE / PERFIL	3000mm (118")	1/10
EM134-CAPS	● Aluminum/Aluminio	CAPS / TAPAS		1/200

**KKD2114 PERFIL**



Material: Aluminum-Includes cut-out screws Material: Aluminio-Incluye tornillos recortables

CODE / CÓDIGO	FINISH / ACABADO	L	P	⊗
KKD2114BL	○ White/Blanco	3000mm (118")	42mm (1-5/8")	8
KKD2114CB	● Bright Aluminum/Aluminio Brillo	3000mm (118")	42mm (1-5/8")	8
KKD2114CM	● Matte Aluminum/Aluminio Mate	3000mm (118")	42mm (1-5/8")	8

**POLONIA**

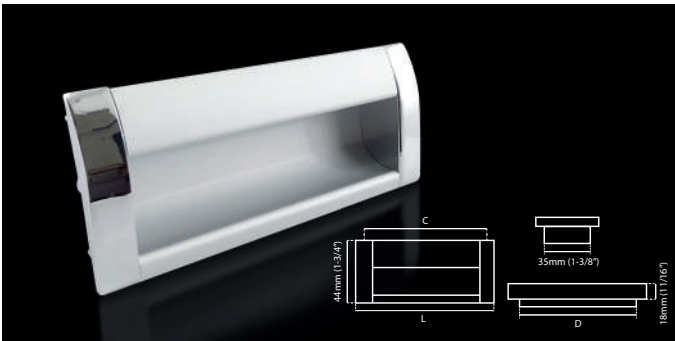

Material: Aluminum-Includes cut-out screws Material: Aluminio-Incluye tornillos recortables

CODE / CÓDIGO	FINISH / ACABADO	C	L	D	⊗
EM034-064-POLONIA	● Aluminum/Aluminio	64mm (2-1/2")	78mm (3-1/16")	69mm (2-11/16")	30/180
EM034-096-POLONIA	● Aluminum/Aluminio	96mm (3-3/4")	110mm (4-5/16")	101mm (4")	25/150
EM034-128-POLONIA	● Aluminum/Aluminio	128mm (5-1/16")	142mm (5-9/16")	133mm (5-1/4")	25/100
EM034-160-POLONIA	● Aluminum/Aluminio	160mm (6-5/16")	175mm (6-7/8")	166mm (6-9/16")	20/80
EM034-3000-POLONIA	● Aluminum/Aluminio	PROFILE / PERFIL	3000mm (118")		

**KKD2010**

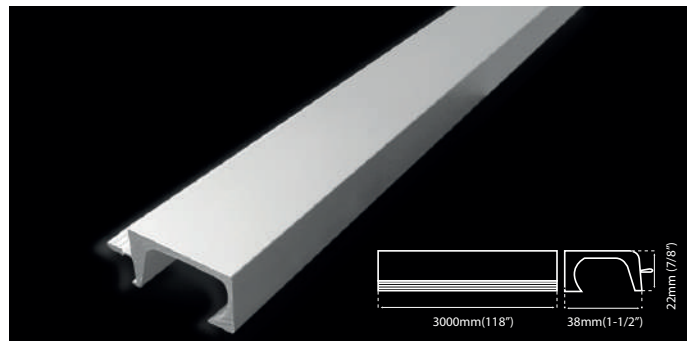

Material: Aluminum-Includes cut-out screws Material: Aluminio-Incluye tornillos recortables

CODE / CÓDIGO	FINISH / ACABADO	⊗
KKD2010BL	○ White/Blanco	8
KKD2010CB	● Bright Aluminum/Aluminio Brillo	8
KKD2010CM	● Matte Aluminum/Aluminio Mate	8

All measurements are approximate / Las medidas son aproximadas

ESPAÑA

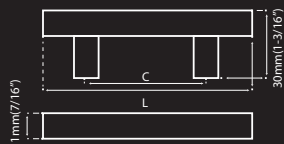
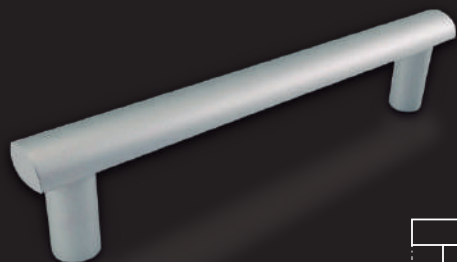

Material: Aluminum - Includes cut-out screws / Material: Aluminio - Incluye tornillos recortables

CODE / CÓDIGO	FINISH / ACABADO	C	L	
EM001-096-ESPAÑA	● Aluminum/Aluminio	96mm(3-3/4")	118mm(4-5/8")	35/210
EM001-128-ESPAÑA	● Aluminum/Aluminio	128mm(5-1/16")	150mm(5-7/8")	30/180
EM001-224-ESPAÑA	● Aluminum/Aluminio	224mm(8-13/16")	350mm(13-3/4")	20/80
EM001-256-ESPAÑA	● Aluminum/Aluminio	256mm(10-1/16")	399mm(15-11/16")	20/80

SUIZA

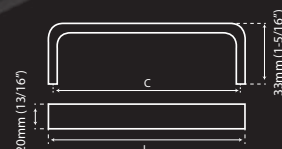
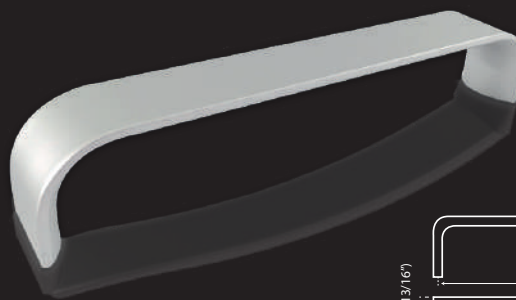

Material: Aluminum - Includes cut-out screws / Material: Aluminio - Incluye tornillos recortables

CODE / CÓDIGO	FINISH / ACABADO	C	L	
EM031-096-SUIZA	● Aluminum/Aluminio	96mm(3-3/4")	103mm(4-1/16")	35/210
EM031-128-SUIZA	● Aluminum/Aluminio	128mm(5-1/16")	135mm(4-1/16")	30/180

MAROCCO

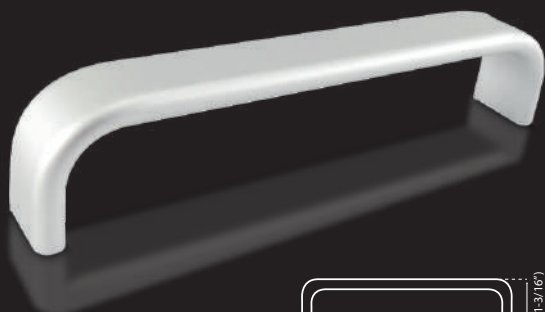

Material: Aluminum - Includes cut-out screws / Material: Aluminio - Incluye tornillos recortables

CODE / CÓDIGO	FINISH / ACABADO	C	L	
EM012-096-MAROCCO	● Aluminum/Aluminio	96mm(3-3/4")	102mm(4")	30/180
EM012-128-MAROCCO	● Aluminum/Aluminio	128mm(5-1/16")	135mm(5-5/16")	25/150
EM012-160-MAROCCO	● Aluminum/Aluminio	160mm(6-5/16")	167mm(6-9/16")	20/120
EM012-224-MAROCCO	● Aluminum/Aluminio	224mm(4-7/8")	231mm(9-1/8")	20/80
EM012-320-MAROCCO	● Aluminum/Aluminio	320mm(12-5/8")	327mm(12-7/8")	20/80
EM012-384-MAROCCO	● Aluminum/Aluminio	384mm(15-1/8")	391mm(15-3/8")	20/80
EM012-096-MAROCCOBLACK	○ Black/Negro	96mm(3-3/4")	102mm(4")	30/180
EM012-128-MAROCCOBLACK	○ Black/Negro	128mm(5-1/16")	135mm(5-5/16")	25/150
EM012-160-MAROCCOBLACK	○ Black/Negro	160mm(6-5/16")	167mm(6-9/16")	20/120
EM012-224-MAROCCOBLACK	○ Black/Negro	224mm(4-7/8")	231mm(9-1/8")	20/80
EM012-320-MAROCCOBLACK	○ Black/Negro	320mm(12-5/8")	327mm(12-7/8")	20/80
EM012-320-MAROCCOMTG	● Matt Brass/Latón Mate	320mm(12-5/8")	327mm(12-7/8")	20/80

CANADÁ

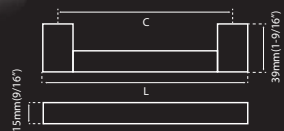

Material: Aluminum - Includes cut-out screws / Material: Aluminio - Incluye tornillos recortables

CODE / CÓDIGO	FINISH / ACABADO	C	L	
EM035-096-CANADA	● Aluminum/Aluminio	96mm(3-3/4")	115mm(4-1/2")	30/180
EM035-128-CANADA	● Aluminum/Aluminio	128mm(5-1/16")	147mm(5-13/16")	25/150

MÉXICO

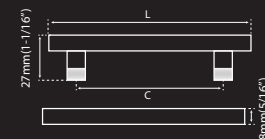
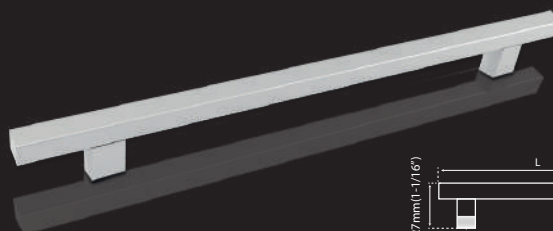

Material: Aluminum - Includes cut-out screws / Material: Aluminio - Incluye tornillos recortables

CODE / CÓDIGO	FINISH / ACABADO	C	L	
EM072-096-MEXICO	● Aluminum/Aluminio	96mm(3-3/4")	147mm(5-13/16")	35/210
EM072-128-MEXICO	● Aluminum/Aluminio	128mm(5-1/16")	179mm(7-1/16")	35/210
EM072-160-MEXICO	● Aluminum/Aluminio	160mm(6-5/16")	211mm(8-5/16")	80/180
EM072-224-MEXICO	● Aluminum/Aluminio	224mm(8-13/16")	275mm(10-13/16")	25/150
EM072-384-MEXICO	● Aluminum/Aluminio	384mm(15-1/8")	435mm(17-1/8")	20/120



### ALEMANIA

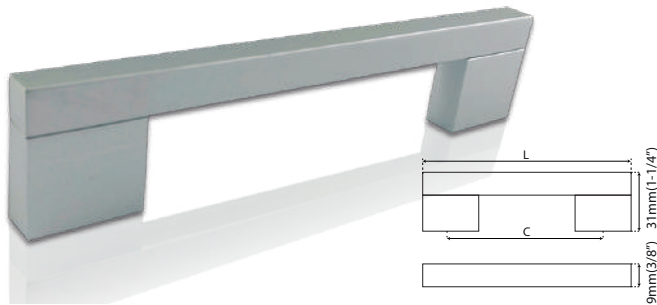

Material: Aluminum - Includes cut-out screws / Material: Aluminio - Incluye tornillos recortables

CODE / CÓDIGO	FINISH / ACABADO	C	L	⊠
EM086-096-ALEMANIA	● Aluminum/Aluminio	96mm (3-3/4")	113mm (4-7/16")	40/240
EM086-128-ALEMANIA	● Aluminum/Aluminio	128mm (5-1/16")	145mm (5-11/16")	30/180

### GRECIA



Material: Aluminum - Includes cut-out screws / Material: Aluminio - Incluye tornillos recortables

CODE / CÓDIGO	FINISH / ACABADO	C	L	⊠
EM123-096-GRECIA	● Aluminum/Aluminio	96mm (3-3/4")	126mm (4-15/16")	30/180
EM123-128-GRECIA	● Aluminum/Aluminio	128mm (5-1/16")	160mm (6-5/16")	25/150

### CROACIA

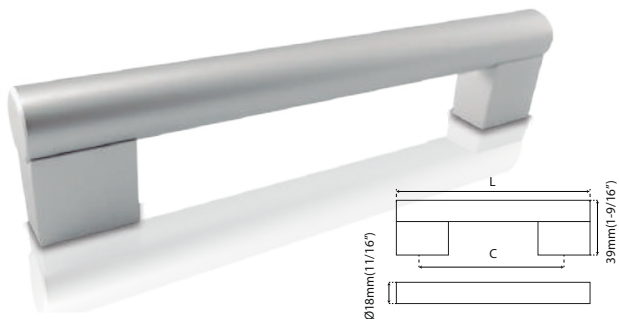

Material: Aluminum - Includes cut-out screws / Material: Aluminio - Incluye tornillos recortables

CODE / CÓDIGO	FINISH / ACABADO	C	L	⊠
EM113-096-CROACIA	● Aluminum/Aluminio	96mm (3-3/4")	110mm (4-5/16")	20/120
EM113-128-CROACIA	● Aluminum/Aluminio	128mm (5-1/16")	141mm (5-9/16")	20/80
EM113-160-CROACIA	● Aluminum/Aluminio	160mm (6-5/16")	174mm (6-7/8")	20/80
EM113-320-CROACIA	● Aluminum/Aluminio	320mm (12-5/8")	360mm (14-3/16")	20/80

### NIGERIA

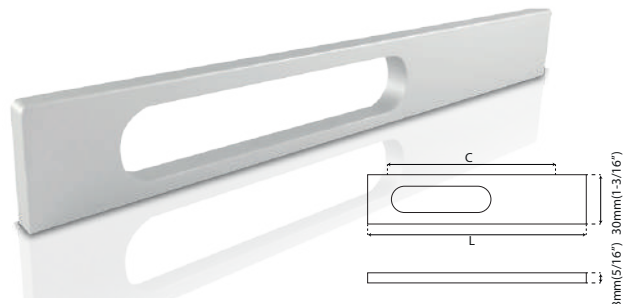

Material: Aluminum - Includes cut-out screws / Material: Aluminio - Incluye tornillos recortables

CODE / CÓDIGO	FINISH / ACABADO	C	L	⊠
EM139-192-NIGERIA	● Aluminum/Aluminio	192mm (7-9/16")	255mm (10-1/16")	25/100
EM139-320-NIGERIA	● Aluminum/Aluminio	320mm (12-5/8")	383mm (15-1/16")	25/100





# CABINET HANDLES / JALADERAS



## PERÚ

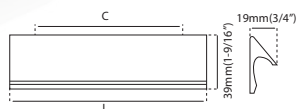
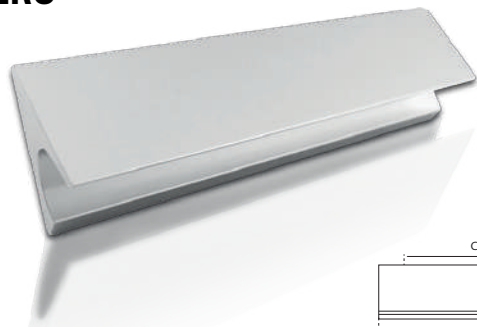

Material: Aluminum - Includes cut-out screws / Material: Aluminio - Incluye tornillos recortables

CODE / CÓDIGO	FINISH / ACABADO	C	L	
EM149-096-PERU	● Aluminum/Aluminio	96mm (3-3/4")	120mm (4-3/4")	180
EM149-128-PERU	● Aluminum/Aluminio	128mm (5-1/16")	150mm (5-7/8")	150
EM149-160-PERU	● Aluminum/Aluminio	160mm (6-5/16")	200mm (7-7/8")	20
EM149-320-PERU	● Aluminum/Aluminio	320mm (12-5/8")	400mm (15-3/4")	20

## INDONESIA

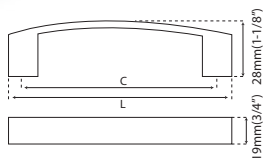

Material: Aluminum - Includes cut-out screws / Material: Aluminio - Incluye tornillos recortables

CODE / CÓDIGO	FINISH / ACABADO	C	L	
EM162-128-INDONESIA	● Aluminum/Aluminio	128mm (5-1/16")	145mm (5-11/16")	25/150

## TURQUÍA

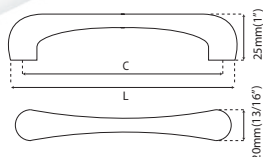

Material: Aluminum - Includes cut-out screws / Material: Aluminio - Incluye tornillos recortables

CODE / CÓDIGO	FINISH / ACABADO	C	L	
EM172-160-TURQUIA	● Bright Aluminum/ Aluminio Brillo	160mm (6-5/16")	190mm (7-1/2")	25/150

## CHILE

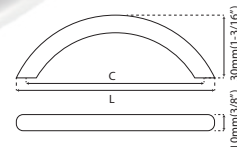

Material: Aluminum - Includes cut-out screws / Material: Aluminio - Incluye tornillos recortables

CODE / CÓDIGO	FINISH / ACABADO	C	L	
EM085-096-CHILE	Aluminum/Aluminio	96mm (3-13/16")	117mm (4-5/8")	50/300
EM085-128-CHILE	Aluminum/Aluminio	128mm (5-1/16")	155mm (6-1/8")	50/300
EM085-160-CHILE	Aluminum/Aluminio	160mm (6-5/16")	193mm (7-5/8")	40/240





## FRANCIA

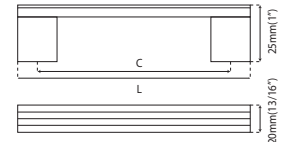
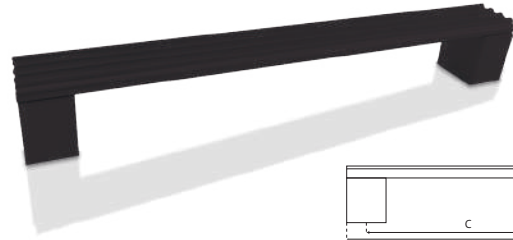

Material: Aluminum - Includes cut-out screws / Material: Aluminio - Incluye tornillos recortables

CODE / CÓDIGO	FINISH / ACABADO	C	L	⊗
EM036-128-FRANCIA	● Aluminum/Aluminio	128mm (5-1/16")	143mm (5-5/8")	25/150
EM036-160-FRANCIA	● Aluminum/Aluminio	160mm (6-5/16")	175mm (6-7/8")	25/150
EM036-128-FRANCIAMB	● Black/Negro	128mm (5-1/16")	143mm (5-5/8")	25/150
EM036-160-FRANCIAMB	● Black/Negro	160mm (6-5/16")	175mm (6-7/8")	25/150

## ARGENTINA

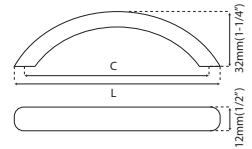

Material: Aluminum - Includes cut-out screws / Material: Aluminio - Incluye tornillos recortables

CODE / CÓDIGO	FINISH / ACABADO	C	L	⊗
EM043-096-ARGENTINA	● Aluminum/Aluminio	96mm (3-13/16")	120mm (4-3/4")	40/240
EM043-128-ARGENTINA	● Aluminum/Aluminio	128mm (5-1/16")	158mm (6-1/4")	30/180
EM043-096-ARGENTINAMB	● Black/Negro	96mm (3-13/16")	120mm (4-3/4")	40/240
EM043-128-ARGENTINAMB	● Black/Negro	128mm (5-1/16")	158mm (6-1/4")	30/180

## FINLANDIA

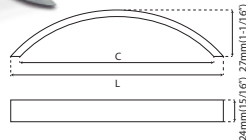

Material: Aluminum - Includes cut-out screws / Material: Aluminio - Incluye tornillos recortables

CODE / CÓDIGO	FINISH / ACABADO	C	L	⊗
EM008-096-FINLANDIA	● Aluminum/Aluminio	96mm (3-3/4")	118mm (4-5/8")	40/240
EM008-128-FINLANDIA	● Aluminum/Aluminio	128mm (5-1/16")	149mm (5-7/8")	35/210

## ITALIA

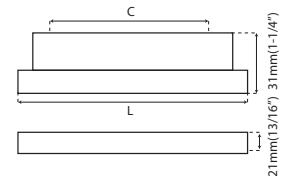
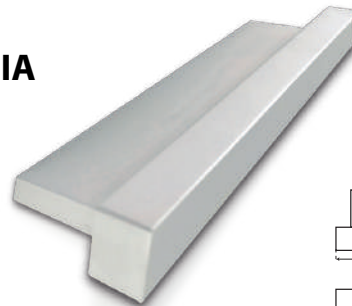

Material: Aluminum - Includes cut-out screws / Material: Aluminio - Incluye tornillos recortables

CODE / CÓDIGO	FINISH / ACABADO	C	L	⊗
EM081-096-ITALIA	● Aluminum/Aluminio	96mm (3-13/16")	120mm (4-3/4")	30/180
EM081-128-ITALIA	● Aluminum/Aluminio	128mm (5-1/16")	150mm (5-7/8")	25/150

### INGLATERRA

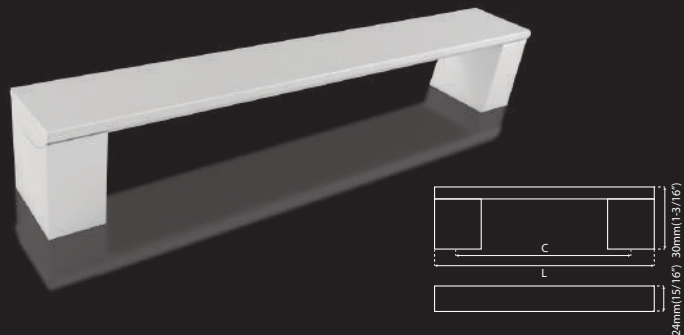

Material: Aluminum - Includes cut-out screws / Material: Aluminio - Incluye tornillos recortables

CODE / CÓDIGO	FINISH/ACABADO	L	P	
EM015-128-INGLATERRA	● Aluminum/Aluminio	128mm (5-1/16")	143mm (5-5/8")	20/120
EM015-160-INGLATERRA	● Aluminum/Aluminio	160mm (6-5/16")	174mm (6-7/8")	20/80
EM015-224-INGLATERRA	● Aluminum/Aluminio	224mm (8-13/16")	239mm (9-7/16")	20/80

### COSTA RICA

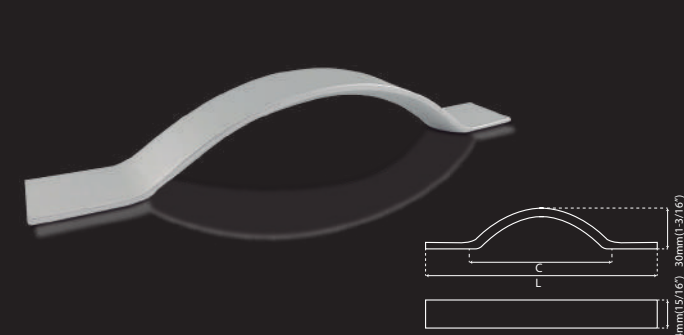

Material: Aluminum - Includes cut-out screws / Material: Aluminio - Incluye tornillos recortables

CODE / CÓDIGO	FINISH/ACABADO	C	L	
EM021-096-COSTARICA	● Aluminum/Aluminio	96mm (3-3/4")	167mm (6-9/16")	25/150
EM021-128-COSTARICA	● Aluminum/Aluminio	128mm (5-1/16")	202mm (7-15/16")	25/150
EM021-160-COSTARICA	● Aluminum/Aluminio	160mm (6-5/16")	234mm (9-3/16")	25/150

### AUSTRIA

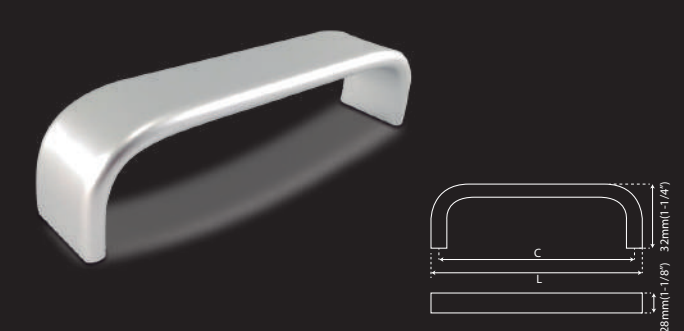

Material: Aluminum - Includes cut-out screws / Material: Aluminio - Incluye tornillos recortables

CODE / CÓDIGO	FINISH/ACABADO	C	L	
EM032-096-AUSTRIA	● Aluminum/Aluminio	96mm (3-3/4")	103mm (4-1/16")	25/150
EM032-128-AUSTRIA	● Aluminum/Aluminio	128mm (5-1/16")	134mm (5-1/4")	20/120
EM032-160-AUSTRIA	● Aluminum/Aluminio	160mm (6-5/16")	167mm (6-9/16")	20/120
EM032-224-AUSTRIA	● Aluminum/Aluminio	224mm (8-13/16")	231mm (9-1/8")	20/80

### KENIA

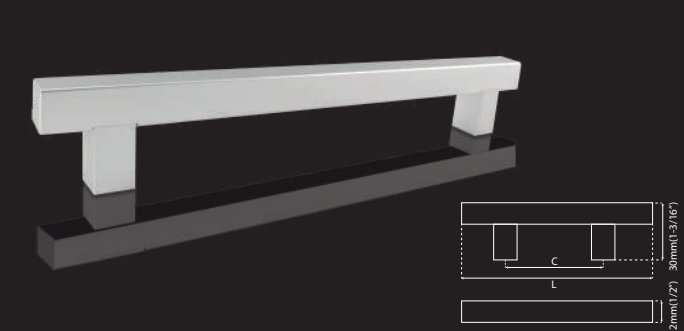

Material: Aluminum - Includes cut-out screws / Material: Aluminio - Incluye tornillos recortables

CODE / CÓDIGO	FINISH/ACABADO	C	L	
EM106-096-KENIA	● Aluminum/Aluminio	96mm (3-13/16")	134mm (5-1/4")	30/180
EM106-128-KENIA	● Aluminum/Aluminio	128mm (5-1/16")	167mm (6-9/16")	25/150
EM106-160-KENIA	● Aluminum/Aluminio	160mm (6-5/16")	198mm (7-13/16")	25/150
EM106-320-KENIA	● Aluminum/Aluminio	320mm (12-5/8")	359mm (14-1/8")	20/100

### HAWÁI

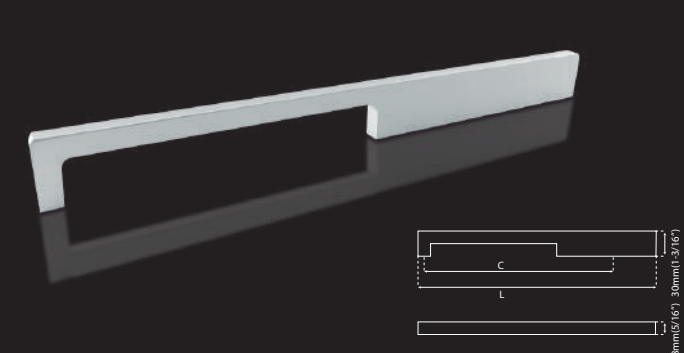

Material: Aluminum - Includes cut-out screws / Material: Aluminio - Incluye tornillos recortables

CODE / CÓDIGO	FINISH/ACABADO	C	L	
EM137-256-HAWAI	● Aluminum/Aluminio	256mm (10-1/16")	320mm (12-5/8")	25/100

### SANMARINO

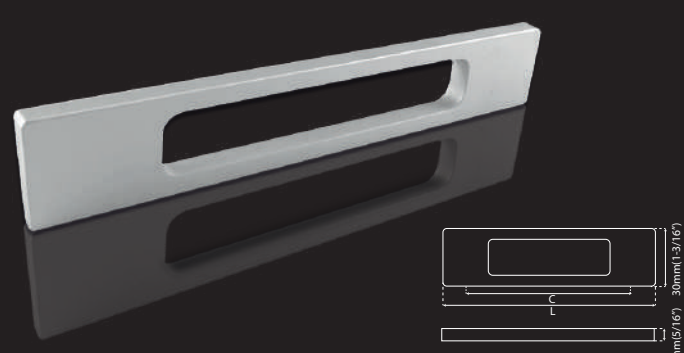

Material: Aluminum - Includes cut-out screws / Material: Aluminio - Incluye tornillos recortables

CODE / CÓDIGO	FINISH/ACABADO	C	L	
EM152-128-SANMARINO	● Aluminum/Aluminio	128mm (5-1/16")	148mm (5-13/16")	30/180
EM152-160-SANMARINO	● Aluminum/Aluminio	160mm (6-5/16")	188mm (7-3/8")	25/150





## PANAMÁ

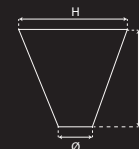

Material: Aluminum - Includes cut-out screws / Material: Aluminio - Incluye tornillos recortables

CODE / CÓDIGO	FINISH / ACABADO	H	P	Ø	
EM186-25-PANAMA	● Aluminum/Aluminio	24mm (15/16")	22mm (7/8")	12mm (1/2")	100/600

## JAMAICA

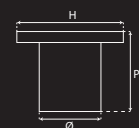

Material: Aluminum - Includes cut-out screws / Material: Aluminio - Incluye tornillos recortables

CODE / CÓDIGO	FINISH / ACABADO	H	P	Ø	
EM189-25-JAMAICA	● Aluminum/Aluminio	24mm (15/16")	25mm (1")	18mm (11/16")	100/600

## HAITÍ

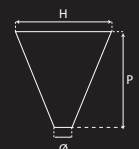

Material: Aluminum - Includes cut-out screws / Material: Aluminio - Incluye tornillos recortables

CODE / CÓDIGO	FINISH / ACABADO	H	P	Ø	
EM187-22-HAITI	● Aluminum/Aluminio	22mm (7/8")	22mm (7/8")	10mm (3/8")	100/600

## PUERTO RICO

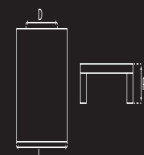
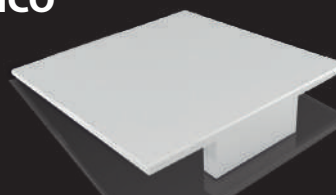

Material: Aluminum - Includes cut-out screws / Material: Aluminio - Incluye tornillos recortables

CODE / CÓDIGO	FINISH / ACABADO	L	P	D	
EM145-32-PUERTORICO	● Aluminum/Aluminio	103mm (4-1/16")	20mm (13/16")	32mm (1-1/4")	15/60

## PORTUGAL

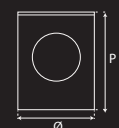

Material: Aluminum - Includes cut-out screws / Material: Aluminio - Incluye tornillos recortables

CODE / CÓDIGO	FINISH / ACABADO	P	Ø	
EM094-016-PORTUGAL-B	● Aluminum/Aluminio	25mm (1")	16mm (5/8")	30/180
EM094-020-PORTUGAL-B	● Aluminum/Aluminio	25mm (1")	20mm (13/16")	30/180
EM094-020-PORTUGAL-BMB	○ Black/Negro	25mm (1")	20mm (13/16")	30/180





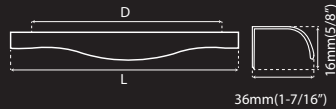

**DENALI**

Material: Aluminum - Includes cut-out screws / Material: Aluminio - Incluye tornillos recortables

CODE / CÓDIGO	FINISH / ACABADO	D	L	☒
KKD4003-197SS	● Aluminum/Aluminio	96mm (3-3/4")	197mm (7-3/4")	25/150
KKD4003-247SS	● Aluminum/Aluminio	147mm (5-13/16")	247mm (9-3/4")	25/100
KKD4003-347SS	● Aluminum/Aluminio	123mm (4-13/16")	347mm (13-11/16")	25/100
KKD4003-197MB	○ Black/Negro	96mm (3-3/4")	197mm (7-3/4")	25/150
KKD4003-247MB	○ Black/Negro	147mm (5-13/16")	247mm (9-3/4")	25/100
KKD4003-347MB	○ Black/Negro	123mm (4-13/16")	347mm (13-11/16")	25/100

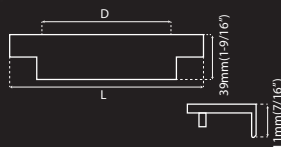
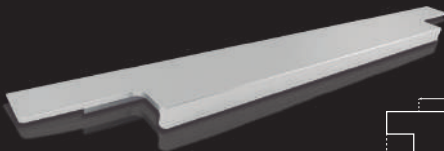
**ARUBA**

Material: Aluminum - Includes cut-out screws / Material: Aluminio - Incluye tornillos recortables

CODE / CÓDIGO	FINISH / ACABADO	D	L	☒
F-ARUBA-147CM	● Matt Aluminum/Aluminio Mate	94mm (3-11/16")	147mm (5-13/16")	25/150
F-ARUBA-297CM	● Matt Aluminum/Aluminio Mate	250mm (9-13/16")	297mm (11-11/16")	25/100
F-ARUBA-347CM	● Matt Aluminum/Aluminio Mate	293mm (11-9/16")	347mm (13-11/16")	25/100
F-ARUBA-397CM	● Matt Aluminum/Aluminio Mate	348mm (13-11/16")	397mm (15-5/8")	25/100
F-ARUBA-147CB	● Bright Aluminum/Aluminio Brillo	94mm (3-11/16")	147mm (5-13/16")	25/150
F-ARUBA-297CB	● Bright Aluminum/Aluminio Brillo	250mm (9-13/16")	297mm (11-11/16")	25/100
F-ARUBA-347CB	● Bright Aluminum/Aluminio Brillo	293mm (11-9/16")	347mm (13-11/16")	25/100
F-ARUBA-397CB	● Bright Aluminum/Aluminio Brillo	348mm (13-11/16")	397mm (15-5/8")	25/100

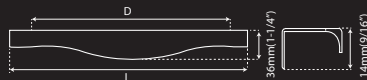
**EVEREST**

Material: Aluminum - Includes cut-out screws / Material: Aluminio - Incluye tornillos recortables

CODE / CÓDIGO	FINISH / ACABADO	D	L	☒
KKD4001-197SS	● Aluminum/Aluminio	95mm (3-3/4")	197mm (7-3/4")	25/150
KKD4001-247SS	● Aluminum/Aluminio	152mm (6")	247mm (9-3/4")	25/100
KKD4001-347SS	● Aluminum/Aluminio	124mm (4-7/8")	347mm (13-11/16")	25/100
KKD4001-197MB	○ Matt Black/ Negro Mate	95mm (3-3/4")	197mm (7-3/4")	25/150
KKD4001-247MB	○ Matt Black/ Negro Mate	152mm (6")	247mm (9-3/4")	25/100
KKD4001-347MB	○ Matt Black/ Negro Mate	124mm (4-7/8")	347mm (13-11/16")	25/100

**BAHAMAS**



Material: Aluminum - Includes cut-out screws / Material: Aluminio - Incluye tornillos recortables

CODE / CÓDIGO	FINISH / ACABADO	C	L	☒
KKD2003-147CB	● Bright Aluminum/Aluminio Brillo	75mm (2-15/16")	147mm (5-13/16")	20
KKD2003-297CB	● Bright Aluminum/Aluminio Brillo	180mm (7-1/16")	297mm (11-11/16")	20
KKD2003-347CB	● Bright Aluminum/Aluminio Brillo	233mm (9-3/16")	347mm (9-3/4")	20
KKD2003-397CB	● Bright Aluminum/Aluminio Brillo	226mm (8-7/8")	397mm (15-5/8")	20
KKD2003-147CM	● Matt Aluminum/Aluminio Mate	75mm (2-15/16")	147mm (5-13/16")	20
KKD2003-297CM	● Matt Aluminum/Aluminio Mate	180mm (7-1/16")	297mm (11-11/16")	20
KKD2003-347CM	● Matt Aluminum/Aluminio Mate	233mm (9-3/16")	347mm (9-3/4")	20
KKD2003-397CM	● Matt Aluminum/Aluminio Mate	226mm (8-7/8")	397mm (15-5/8")	20



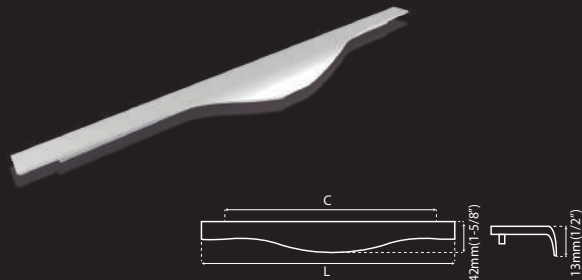

## FLORIDA



Material: Aluminum - Includes cut-out screws / Material: Aluminio - Incluye tornillos recortables

CODE / CÓDIGO	FINISH / ACABADO	C	L	
KKD2113-147CM	● Matte Aluminum/Aluminio Mate	80mm(3-1/8")	147mm(5-13/16")	30/180
KKD2113-297CM	● Matte Aluminum/Aluminio Mate	133mm(5-1/4")	297mm(11-11/16")	30/180
KKD2113-347CM	● Matte Aluminum/Aluminio Mate	228mm(9")	347mm(13-11/16")	25/100
KKD2113-397CM	● Matte Aluminum/Aluminio Mate	280mm(11")	397mm(15-5/8")	25/100
KKD2113-147CB	● Bright Aluminum/Aluminio Brillo	80mm(3-1/8")	147mm(5-13/16")	25/100
KKD2113-297CB	● Bright Aluminum/Aluminio Brillo	133mm(5-1/4")	297mm(11-11/16")	25/100
KKD2113-347CB	● Bright Aluminum/Aluminio Brillo	228mm(9")	347mm(13-11/16")	25/100
KKD2113-397CB	● Bright Aluminum/Aluminio Brillo	280mm(11")	397mm(15-5/8")	25/100

## TRINIDAD

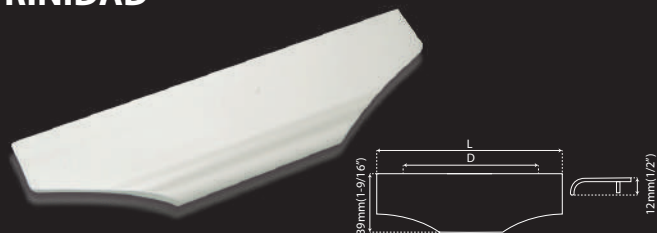

Material: Aluminum - Includes cut-out screws / Material: Aluminio - Incluye tornillos recortables

CODE / CÓDIGO	FINISH / ACABADO	D	L	
KKD2104-147CM	● Matte Aluminum/Aluminio Mate	74mm(2-15/16")	147mm(5-13/16")	30/180
KKD2104-297CM	● Matte Aluminum/Aluminio Mate	228mm(9")	297mm(11-11/16")	25/100
KKD2104-347CM	● Matte Aluminum/Aluminio Mate	228mm(9")	347mm(13-11/16")	25/100
KKD2104-397CM	● Matte Aluminum/Aluminio Mate	230mm(9-1/16")	397mm(15-5/8")	25/100
KKD2104-147CB	● Bright Aluminum/Aluminio Brillo	74mm(2-15/16")	147mm(5-13/16")	30/180
KKD2104-297CB	● Bright Aluminum/Aluminio Brillo	228mm(9")	297mm(11-11/16")	25/100
KKD2104-347CB	● Bright Aluminum/Aluminio Brillo	228mm(9")	347mm(13-11/16")	25/100
KKD2104-397CB	● Bright Aluminum/Aluminio Brillo	230mm(9-1/16")	397mm(15-5/8")	25/100

## HAVANA



Material: Aluminum - Includes cut-out screws / Material: Aluminio - Incluye tornillos recortables

CODE / CÓDIGO	FINISH / ACABADO	C	L	
KKD2100-147CB	● Bright Aluminum/Aluminio Brillo	53mm(2-1/16")	147mm(5-13/16")	20
KKD2100-297CB	● Bright Aluminum/Aluminio Brillo	203mm(8")	297mm(11-11/16")	20
KKD2100-347CB	● Bright Aluminum/Aluminio Brillo	254mm(10")	347mm(13-11/16")	20
KKD2100-397CB	● Bright Aluminum/Aluminio Brillo	317mm(12-1/2")	397mm(15-5/8")	20
KKD2100-147CM	● Matt Aluminum/Aluminio Mate	53mm(2-1/16")	147mm(5-13/16")	20
KKD2100-297CM	● Matt Aluminum/Aluminio Mate	203mm(8")	297mm(11-11/16")	20
KKD2100-347CM	● Matt Aluminum/Aluminio Mate	254mm(10")	347mm(13-11/16")	20
KKD2100-397CM	● Matt Aluminum/Aluminio Mate	317mm(12-1/2")	397mm(15-5/8")	20

## ACONCAGUA

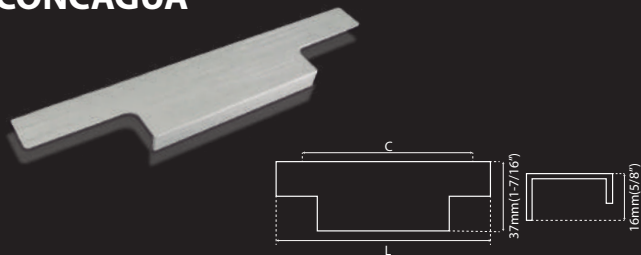

Material: Aluminum - Includes cut-out screws / Material: Aluminio - Incluye tornillos recortables

CODE / CÓDIGO	FINISH / ACABADO	C	L	
KKD4002-197SS	● Aluminum/Aluminio	96mm(3-3/4")	197mm(7-3/4")	25/150
KKD4002-247SS	● Aluminum/Aluminio	146mm(5-3/4")	247mm(9-3/4")	25/100
KKD4002-347SS	● Aluminum/Aluminio	122mm(4-13/16")	347mm(13-11/16")	25/100
KKD4002-197MB	○ Black/Negro	96mm(3-3/4")	197mm(7-3/4")	25/150
KKD4002-247MB	○ Black/Negro	146mm(5-3/4")	247mm(9-3/4")	25/100
KKD4002-347MB	○ Black/Negro	122mm(4-13/16")	347mm(13-11/16")	25/100



**NORUEGA**

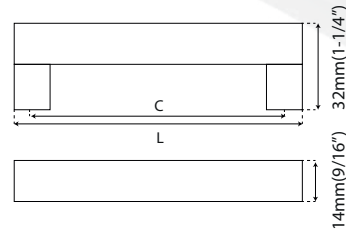
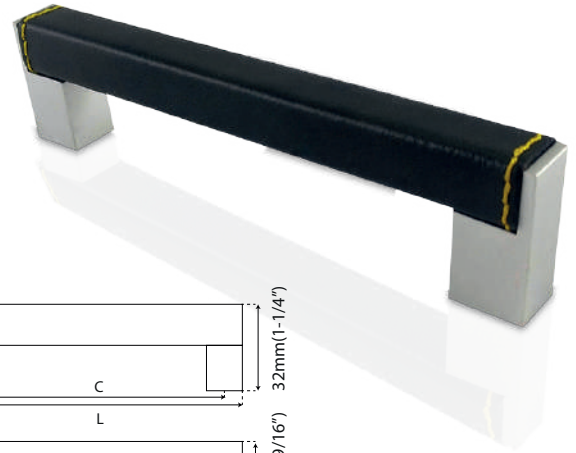

Material: Aluminum - Includes cut-out screws / Material: Aluminio - Incluye tornillos recortables

CODE / CÓDIGO	FINISH / ACABADO	C	L	
EM155-096-NORUEGA	● Black Leather / Piel Negra	96mm (3-13/16")	116mm (4-9/16")	30/180
EM155-128-NORUEGA	● Black Leather / Piel Negra	128mm (5-1/16")	148mm (1-7/8")	25/150
EM155-320-NORUEGA	● Black Leather / Piel Negra	320mm (12-5/8")	340mm (13-3/8")	20/80

**SUECIA**

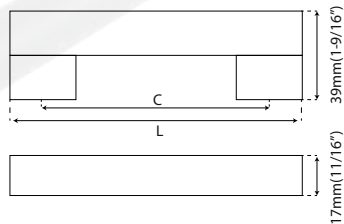
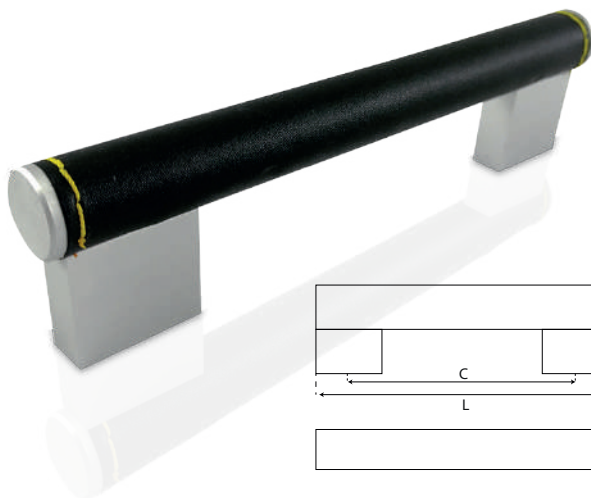

Material: Aluminum - Includes cut-out screws / Material: Aluminio - Incluye tornillos recortables

CODE / CÓDIGO	FINISH / ACABADO	C	L	
EM156-096-SUECIA	● Black Leather / Piel Negra	96mm (3-13/16")	116mm (4-9/16")	30/180
EM156-128-SUECIA	● Black Leather / Piel Negra	128mm (5-1/16")	149mm (5-7/8")	25/150
EM156-320-SUECIA	● Black Leather / Piel Negra	320mm (12-5/8")	342mm (13-7/16")	20/80



All measurements are approximate / Las medidas son aproximadas





# CATALOG · CATÁLOGO



ARCHITECTURAL HARDWARE · HERRAJES ARQUITECTÓNICOS



USA Page: [www.jakohardware.com](http://www.jakohardware.com)



Página México: [www.jako.mx](http://www.jako.mx)